

# MANUAL INSTALLATION

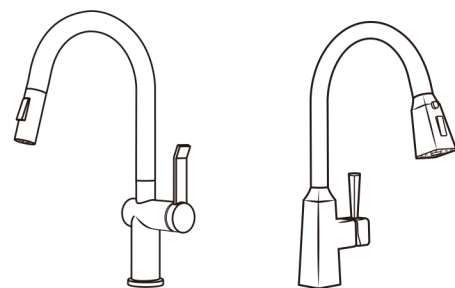

## Pre-Installation

### PACKAGE CONTENTS

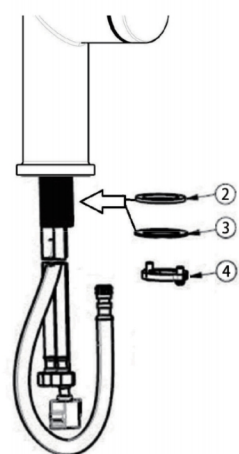

Part	Description	Quantity
1	Weight	1
2	Rubber gasket	1
3	Steel gasket	1
4	Nut	1

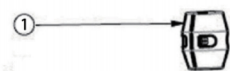

### TOOLS AND HARDWARE REQUIRED

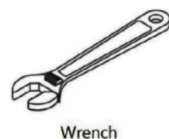
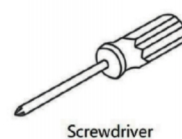

## Installation

### 1. Installing the faucet assembly

**CAUTION:** Always shut off the water supply before removing an existing faucet or replacing any part of a faucet. Open the faucet handle to relieve water pressure and ensure that the water is completely shut off.

**NOTE:** This step is for no escutcheon installation (optional). If the escutcheon will be used, install the faucet assembly as described in step 2.

- Shut off the water supply.
- Insert the faucet body through the hole in the sink.

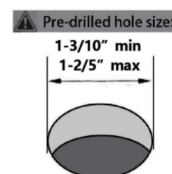
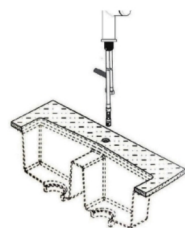

### 2. Partially thread the screws into the ring until they extend 1/4" (6mm) out the opposite side.

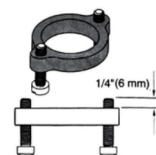

**NOTE:** Put the spray hose into the ring in the order shown on the picture.

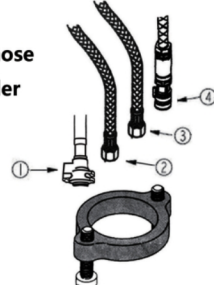

### 3. Slide on the washers and thread the ring onto the shank.

**NOTE:**  
Max countertop thickness without deck plate: 2.7"  
Max countertop thickness with deck plate: 2.4"

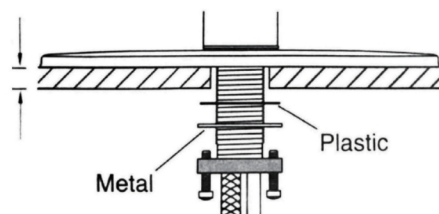

### 4. Position the screws to the front and back. Tighten the screws.

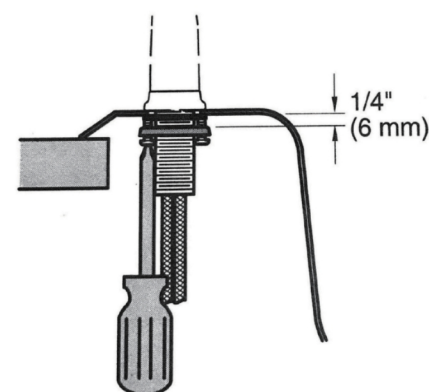

### 7. Loosely attach the weight to the spray hose.

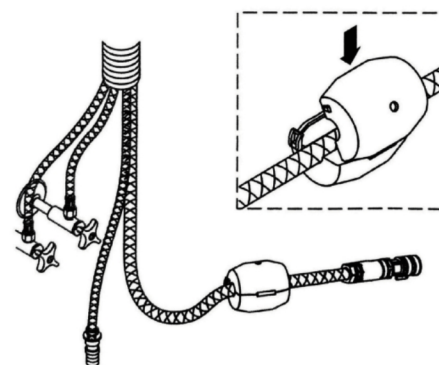

### 5. Making the water supply connections

**NOTE:** The hot side and cold side inlet tube are indicated by color. Red for Hot side and Blue for Cold side. Avoid twisting wires together or placing the wires close to each other and damaging.

- Thread the nut (1) on the supply line onto the outlet of the water supply valve (2) and tighten with a wrench. Do not over-tighten.

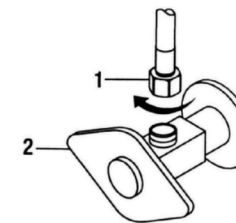

### 8. Connect the spray hose to the quick connector.

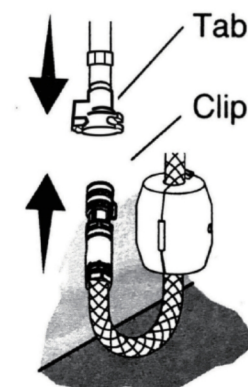

### 6. Turn on the water, flush the hot and cold water for 1 minute and check for leaks.

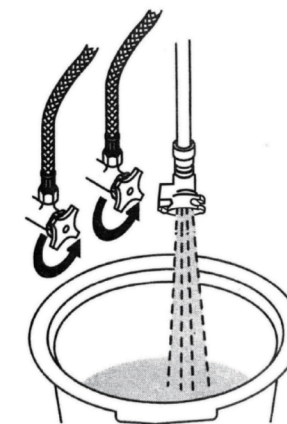

### 9. Properly tighten the weight on the spray Hose as shown.

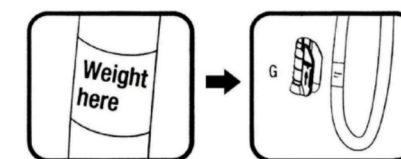
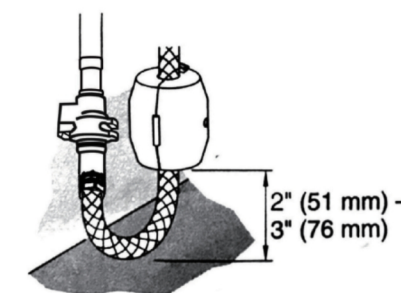

## Faucet Maintenance

### 1 With the water running, rub nozzles to dislodge debris.



### 2 To improve the flow, disconnect the sprayhead, then clean the screen washer. Reassemble.

