

WARNING

WE RECOMMEND INSTALLATION OF THIS LIGHTING FIXTURE BE DONE BY A LICENSED ELECTRICIAN.

WARNING *** SWITCH OFF THE MAIN ELECTRICAL SUPPLY FROM THE MAIN FUSE BOX/CIRCUIT BREAKER BEFORE INSTALLATION.

INSPECT ITEM CAREFULLY BEFORE ATTEMPTING TO INSTALL. IF THERE IS ANY DAMAGE OR OBVIOUS DEFECT, DO NOT INSTALL. ITEM MAY NOT BE RETURNED ONCE IT HAS BEEN INSTALLED.

CARE AND MAINTENANCE

* To clean the outside of the fixture, use a dry or slightly dampened clean cloth (use clean water, never a solvent) to wipe the surface of the fixture.

* To clean the inside of the fixture, first disconnect power to the fixture by turning off the circuit breaker or by removing the fuse at the fuse box. Next, use a dry or slightly dampened clean cloth (use clean water, never a solvent) to wipe the interior surface of the fixture.

* Do not use any cleaners with chemical, solvents or harsh abrasives. Use only a dry soft cloth to dust or wipe carefully.

NOTICE& IMPORTANT SAFETY INSTRUCTIONS

* Please make sure that you have all parts indicated before you begin assembly of this item







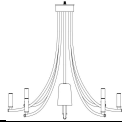

* This item should be assembled on a soft surface to prevent scratching the finish during assembly

* To reduce the risk of fire, electrical shock or injury to persons or property, please follow the guideline below for safe use and installation

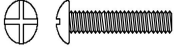
*The external flexible cable or cord of this luminaire cannot be replaced

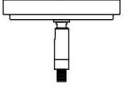
If the cord is damaged, the luminaire shall be destroyed

Part List and Hardware List

PIECE	DESCRIPTION	PICTURE	QUANTITY	PIECE	DESCRIPTION	PICTURE	QUANTITY
A	mounting Plate		1X	G	fixture arms		1X
B	wire nut		3X	H	bulb		10X
C	mounting Screw		2X	I	bulb		1X
D	Canopy		1X	J	fixture ring		1X
E	Screwed Ball		2X	K	finial		10X
F	tube		12" - 2X 6" - 2X				

JY
JONATHAN Y

Model#: JYL2506

Product Dimensions:30"LX30"W X 36-66"H

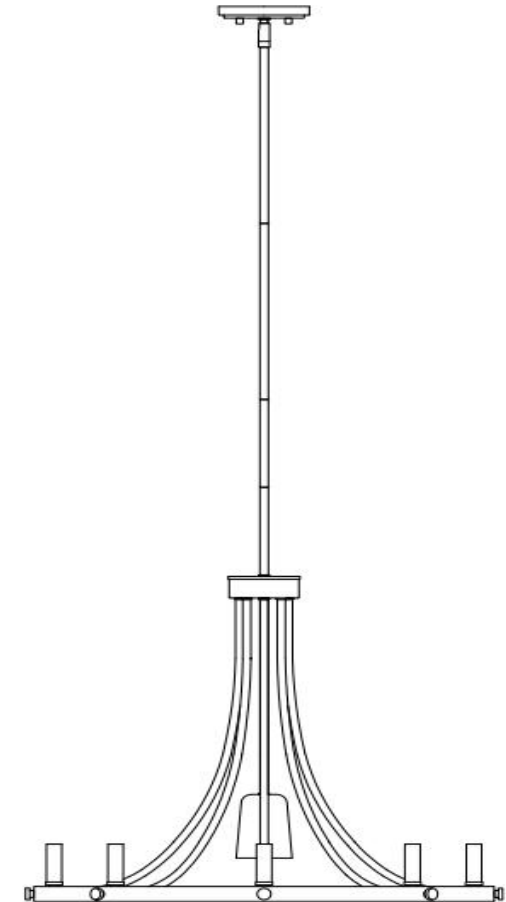

PREPARATION

Before beginning assembly of product, make sure all parts are present. Compare parts with package contents list : hardware contents list. If any part is missing or damaged, do not attempt to assemble the product.

Estimated Assembly Time: 20 minutes.

If there are any questiong relating to defects, missing parts, assembly issues, replacements, or device connectivity issu please send a detailed email to cs@jonathany.com

1. Separate the Mounting Plate(A) from the Canopy(D) by removing the Screwed Ball(E) anti-clockwise. , then fix the mounting plate(A) to the outlet box with machine screw(C).
2. Spread fixture arms (G) to an equal distance apart. Attach fixture ring (J) to the fixture arms (G) by finials (K).
3. Connect the tubes(F) together to get desired length and fix the bottom end to nipple on the top of fixture, the top end to the canopy(D) on the swivel.
4. Make wire connections, with wire nut(B), following the reference chart listed below.

Connect, Hot, Black or Red Outlet Supply Wire to:	Connect, Neutral, White Outlet Supply Wire to:
Black	White
* Parallel Cord (round & smooth)	* Parallel Cord (square & ridged)
Clear, Brown, Gold or Black without Tracer (colored stripes)	Clear, Brown, Gold or Black with Tracer (colored stripes)
Insulated Wire (not green) with copper metal conductor	Insulated Wire (not green) with Silver metal conductor.

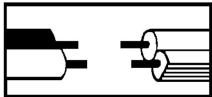

*Note: When parallel wire (SPT I & SPT II) is used. The neutral wire is square shaped and ridged and the hot wire will be round in shape and smooth. (See Illustration on left.)

Grounding Instructions:

- a) For installation in the United States: Wrap ground wire from outlet box around green ground screw on mounting plate, no less than 2" from wire end. Tighten ground screw. If fixture is supplied with a ground wire, connect to outlet ground wire with a wire connector.
- b) For installation in Canada: If fixture is supplied with ground wire, wrap ground wire around green grounding screw on mounting plate. Tighten ground screw.

4. Attach the Canopy(D) to the Mounting Plate (A) and fix it by turning the Screwed Ball (E) clockwise.
5. Install bulb(H) and (I). Be sure to use light bulb(s) with wattage no greater than specified on this fixture. Always make sure that electrical current is turned off before changing bulbs.

PLEASE USE ON/OFF TYPE "A" BULB MAX 40-WATT OR LED BULB MAX9 -WATT, THERE IS LED 1PC 4WATT BULB IN THE BOX, AND PLEASE USE ON/OFF TYPE "B" BULB MAX 40-WATT OR LED BULB MAX9 -WATT, THERE ARE LED 10PCS 4WATT BULB IN THE BOX

ENJOY YOUR LAMP

